

2MBI1400VXB-120E-54

IGBT Modules

IGBT MODULE (V series) 1200V / 1400A / 2 in one package

■ Features

- High speed switching
- Voltage drive
- Low Inductance module structure

■ Applications

- Inverter for Motor Drive
- AC and DC Servo Drive Amplifier
- Uninterruptible Power Supply
- Industrial machines, such as Welding machines



■ Maximum Ratings and Characteristics

● Absolute Maximum Ratings (at Tc=25°C unless otherwise specified)

Items	Symbols	Conditions	Maximum ratings	Units	
Inverter	Collector-Emitter voltage	V_{CES}	1200	V	
	Gate-Emitter voltage	V_{GES}	± 20	V	
	Collector current	I_c	Continuous	Tc=25°C	1800
				Tc=100°C	1400
		$I_{c\ pulse}$	1ms	2800	A
		$-I_c$		1400	
		$-I_{c\ pulse}$	1ms	2800	
Collector power dissipation	P_C	1 device	7650	W	
Junction temperature	T_j		175		
Operating junction temperature (under switching conditions)	T_{jop}		150	°C	
Case temperature	T_c		150		
Storage temperature	T_{stg}		-40 ~ +150		
Isolation voltage	between terminal and copper base (*1)	V_{iso}	AC : 1min.	4000	VAC
	between thermistor and others (*2)				
Screw torque (*3)	Mounting		M5	6.0	N m
	Main Terminals		M8	10.0	
	Sense Terminals		M4	2.1	

Note *1: All terminals should be connected together during the test.

Note *2: Two thermistor terminals should be connected together, other terminals should be connected together and shorted to base plate during the test.

Note *3: Recommendable Value : Mounting 3.0 ~ 6.0 Nm (M5) Recommendable Value : Main Terminals 8.0 ~ 10.0 Nm (M8)
Recommendable Value : Sense Terminals 1.8 ~ 2.1 Nm (M4)

● Electrical characteristics (at Tj= 25°C unless otherwise specified)

Items	Symbols	Conditions	Characteristics			Units		
			min.	typ.	max.			
Inverter	Zero gate voltage collector current	I_{CES}	$V_{GE} = 0V, V_{CE} = 1200V$	-	-	12.0	mA	
	Gate-Emitter leakage current	I_{GES}	$V_{CE} = 0V, V_{GE} = \pm 20V$	-	-	2400	nA	
	Gate-Emitter threshold voltage	$V_{GE(th)}$	$V_{CE} = 20V, I_c = 1400mA$	6.0	6.5	7.0	V	
	Collector-Emitter saturation voltage	$V_{CE(sat)}$ (terminal) (*4)	$V_{GE} = 15V$ $I_c = 1400A$	Tj=25°C	-	1.85	2.30	V
				Tj=125°C	-	2.15	-	
		Tj=150°C		-	2.20	-		
		$V_{CE(sat)}$ (chip)		Tj=25°C	-	1.75	2.20	
		Tj=125°C		-	2.05	-		
	Tj=150°C	-	2.10	-				
	Internal gate resistance	$R_{g(int)}$	-	-	0.79	-	Ω	
	Input capacitance	C_{ies}	$V_{CE} = 10V, V_{GE} = 0V, f = 1MHz$	-	128	-	nF	
	Turn-on time	t_{on}	$V_{CC}=600V, I_c=1400A, V_{GE}=\pm 15V,$ $R_g=1\Omega, L_s=60nH$	-	1000	-	nsec	
		t_r		-	400	-		
		$t_r(i)$		-	150	-		
	Turn-off time	t_{off}		-	1200	-	nsec	
t_f			-	150	-			
Forward on voltage	V_F (terminal) (*4)	$V_{GE} = 0V$ $I_F = 1400A$	Tj=25°C	-	1.90	2.35	V	
			Tj=125°C	-	2.05	-		
	Tj=150°C		-	2.00	-			
	V_F (chip)		Tj=25°C	-	1.80	2.25		
	Tj=125°C		-	1.95	-			
Tj=150°C	-	1.90	-					
Reverse recovery time	t_{rr}	$I_F = 1400A$	-	200	-	nsec		
Thermistor Resistance	R	T=25°C	-	5000	-	Ω		
		T=100°C	465	495	520			
Thermistor B value	B	T=25/50°C	3305	3375	3450	K		

Note *4: Please refer to page 6 , there is definition of on-state voltage at terminal.

● Thermal resistance characteristics

Items	Symbols	Conditions	Characteristics			Units
			min.	typ.	max.	
Thermal resistance (1device)	$R_{th(j-c)}$	Inverter IGBT	-	-	0.0195	°C/W
		Inverter FWD	-	-	0.0360	
Contact thermal resistance (1device) (*5)	$R_{th(c-f)}$	with Thermal Compound	-	0.00420	-	

Note *5: This is the value which is defined mounting on the additional cooling fin with thermal compound.

■ Characteristics (Representative)

[INVERTER]

Collector current vs. Collector-Emitter voltage (typ.)
Tj= 25°C / chip

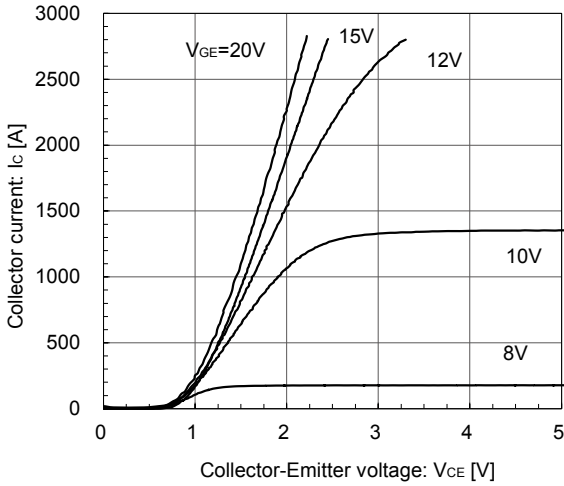

[INVERTER]

Collector current vs. Collector-Emitter voltage (typ.)
Tj= 150°C / chip

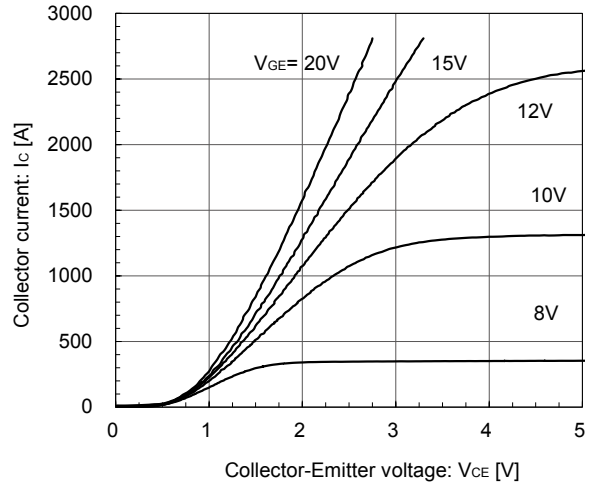

[INVERTER]

Collector current vs. Collector-Emitter voltage (typ.)
VGE= 15V / chip

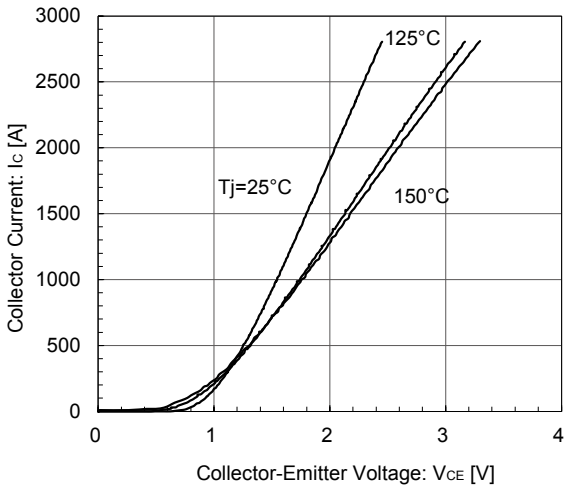

[INVERTER]

Collector-Emitter voltage vs. Gate-Emitter voltage (typ.)
Tj= 25°C / chip

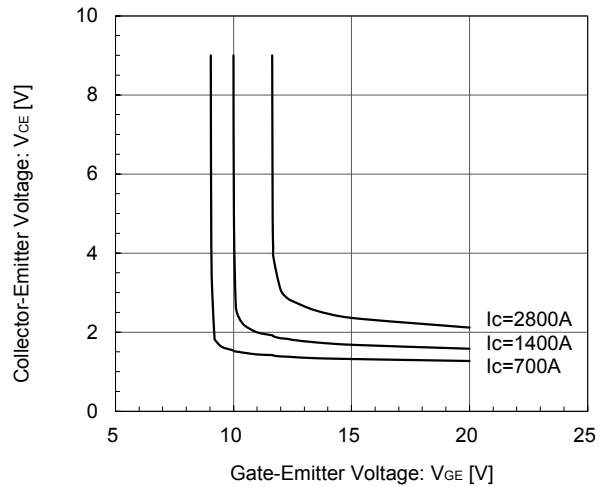

[INVERTER]

Gate Capacitance vs. Collector-Emitter Voltage (typ.)
VGE= 0V, f= 1MHz, Tj= 25°C

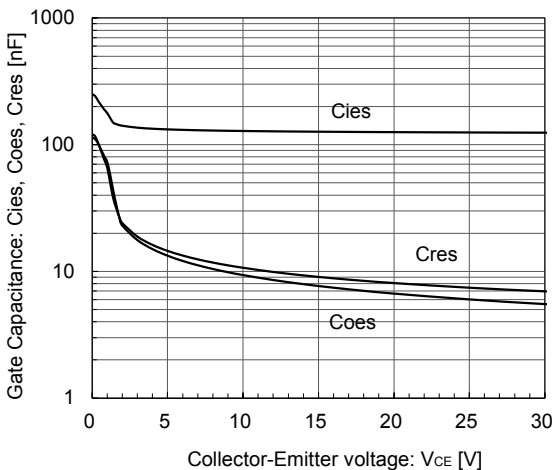

[INVERTER]

Dynamic Gate Charge (typ.)
Vcc=600V, Ic=1400A, Tj= 25°C

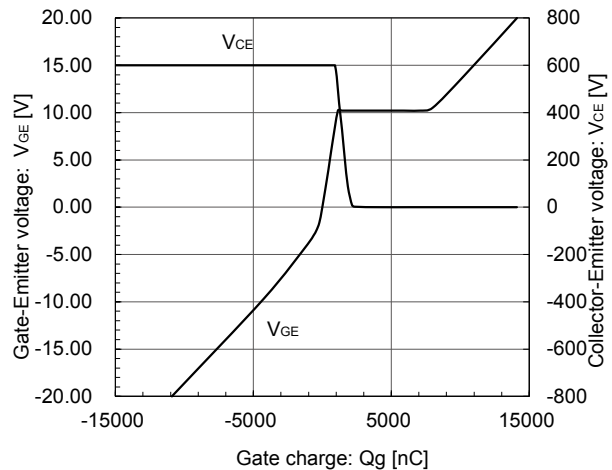

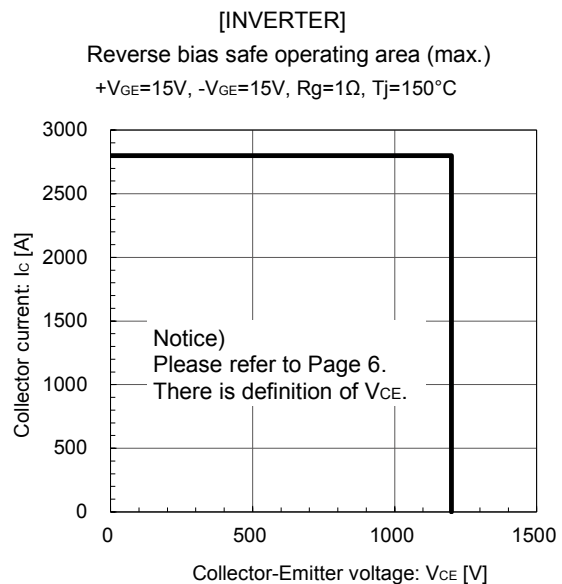
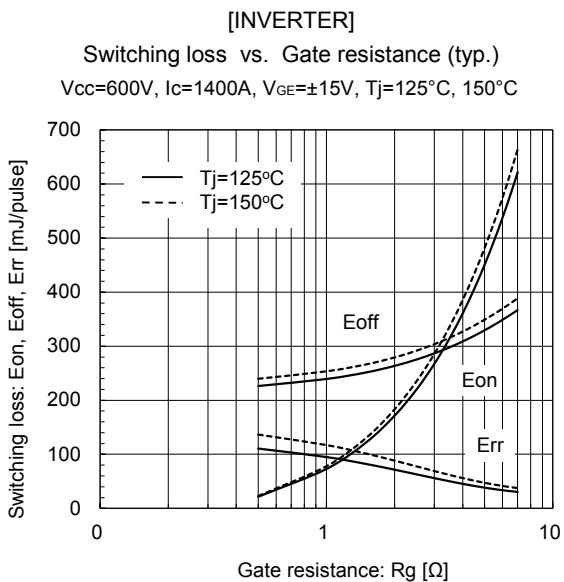
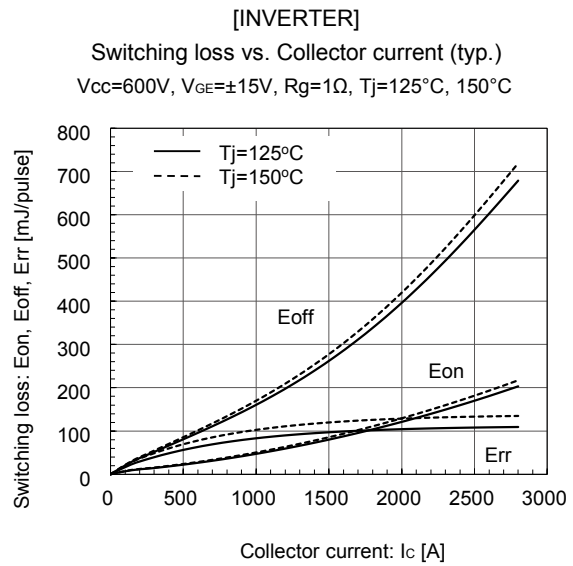
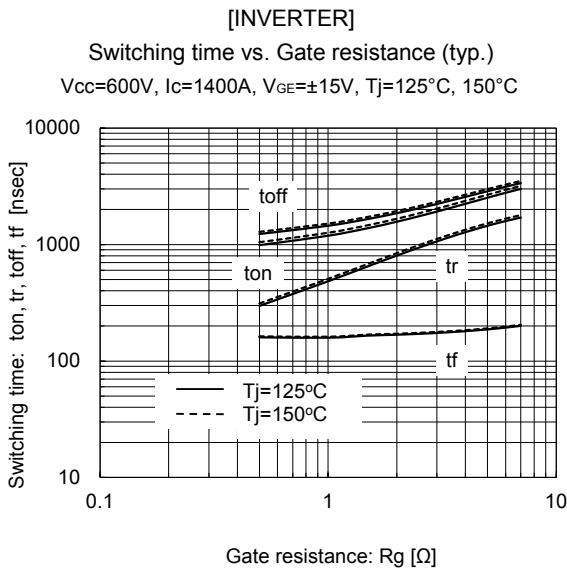
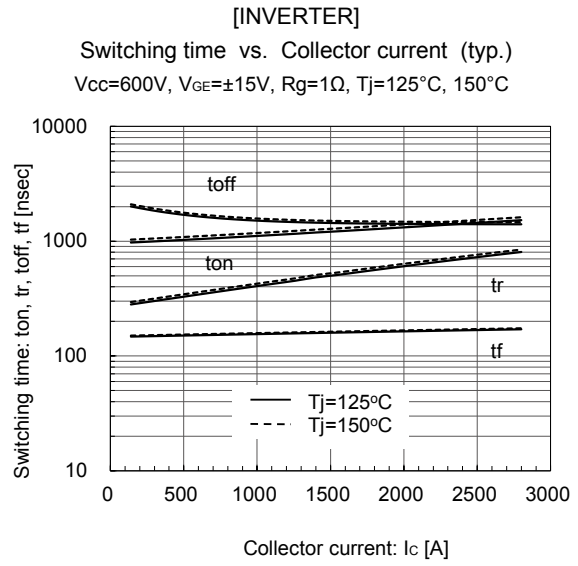
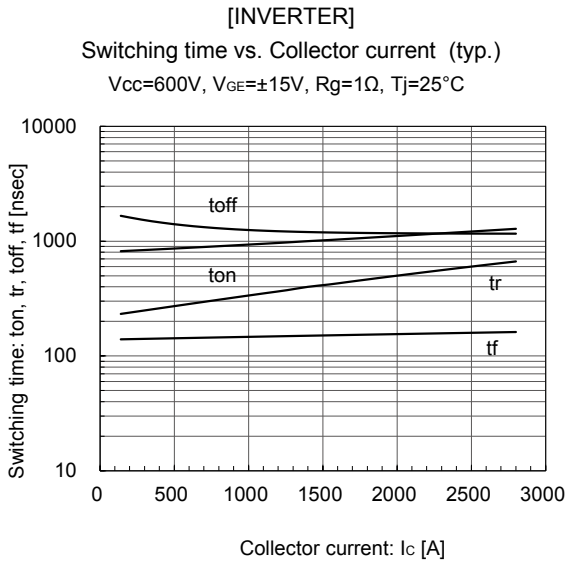

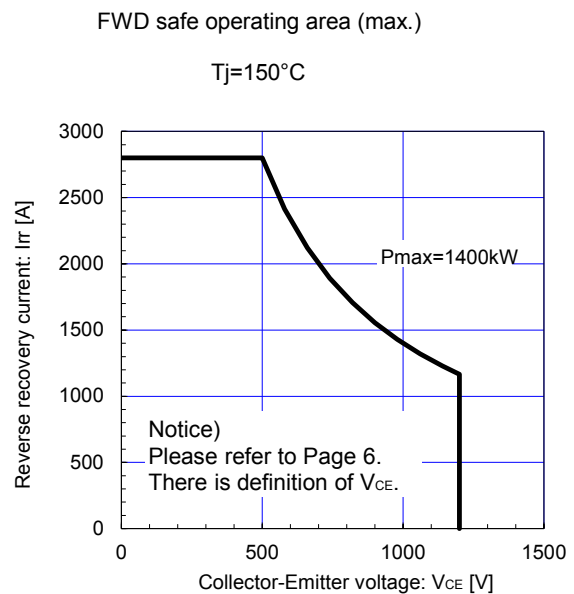
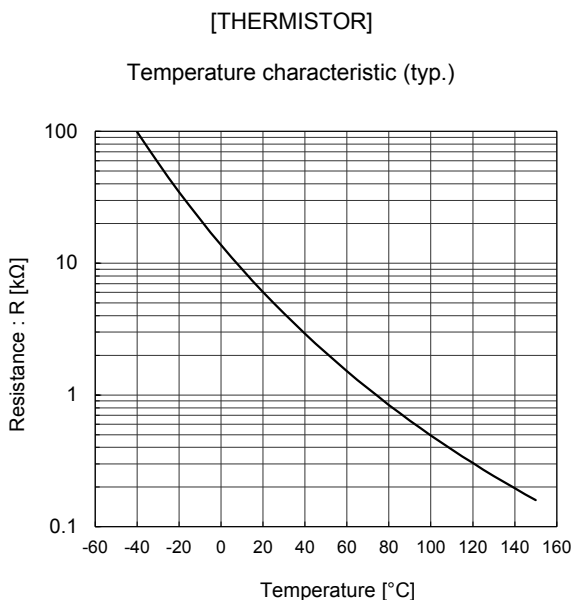
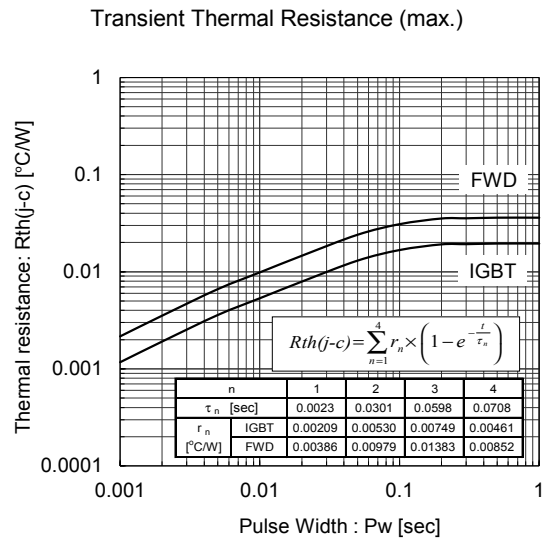
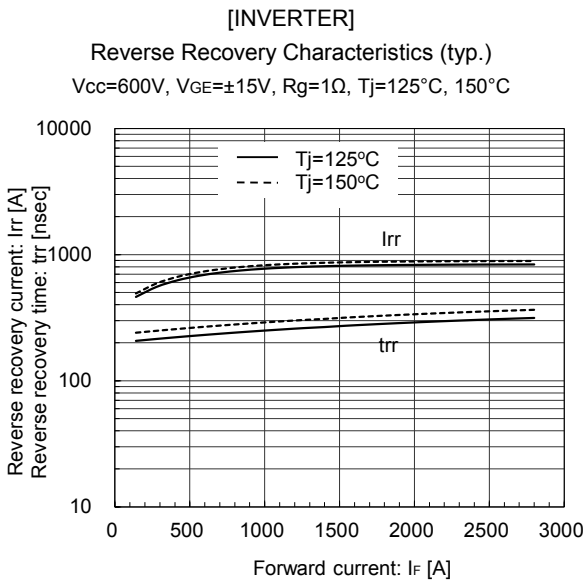
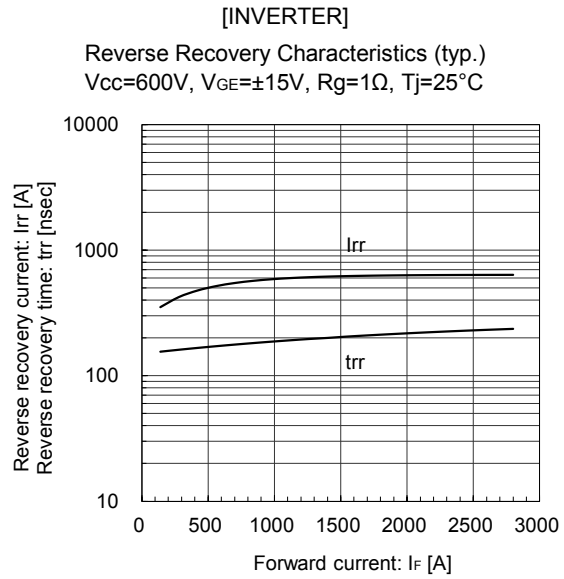
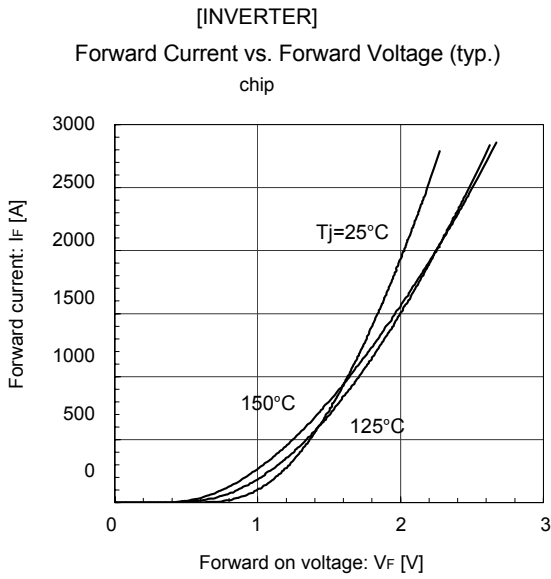

■ Outline Drawings, mm

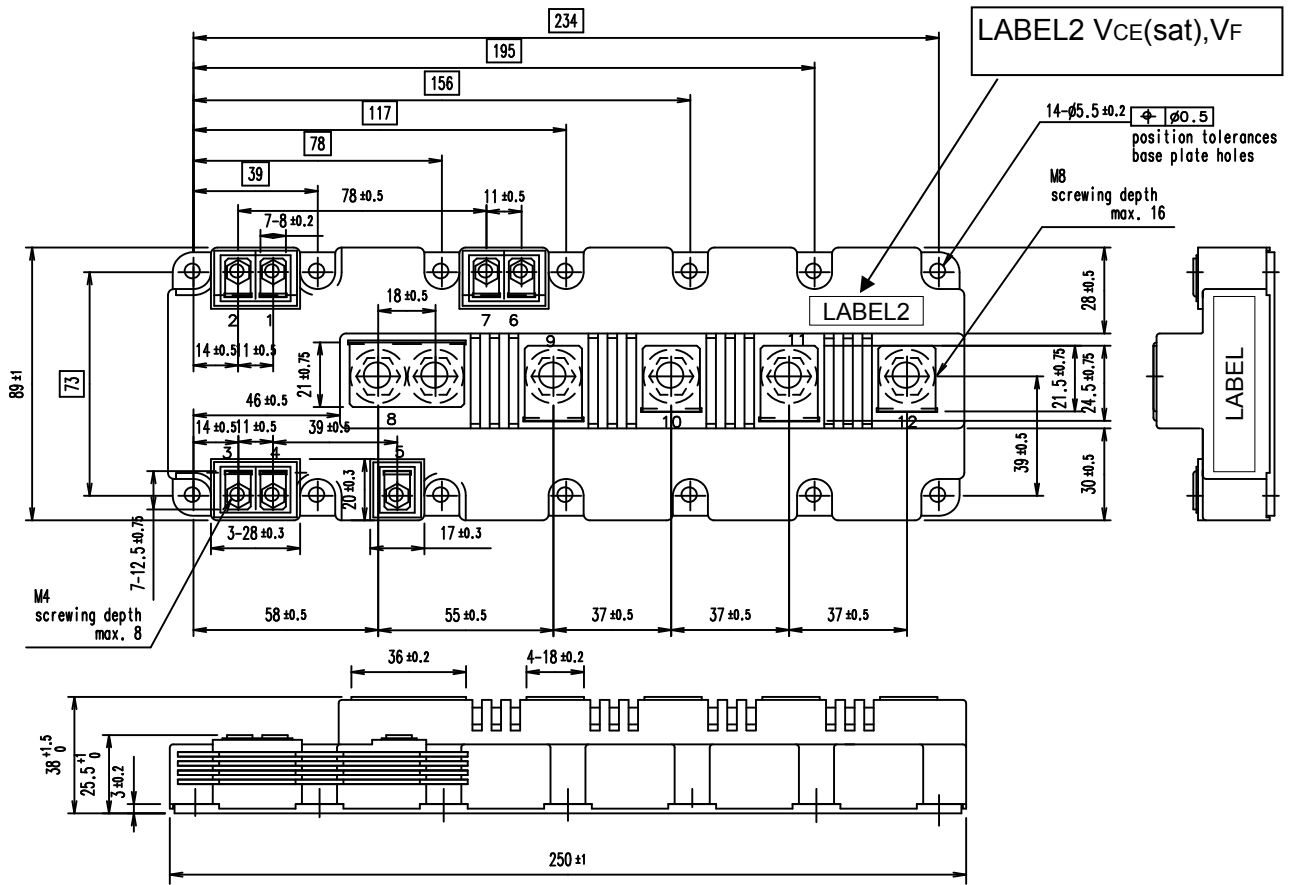

Weight: 1250g(typ.)

■ Equivalent Circuit Schematic

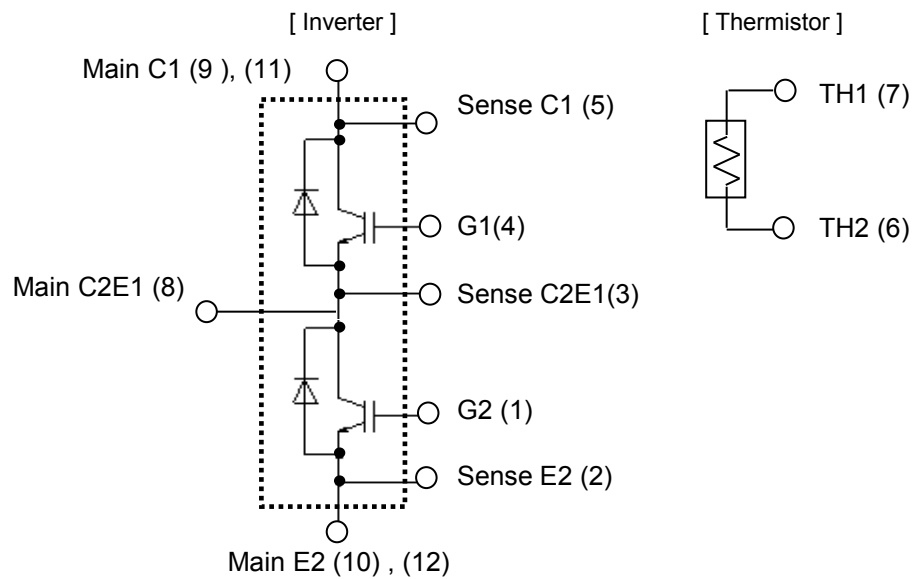

■ Definition of on-state voltage at terminal and switching characteristics

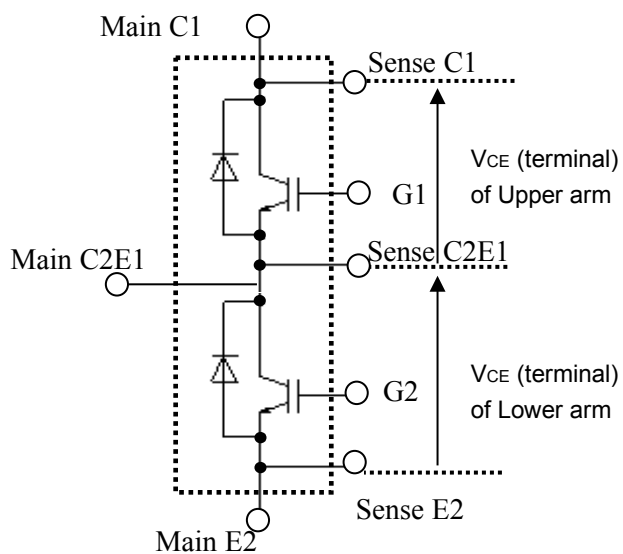

Fuji defined V_{CE} value of terminal by using Sense C1 and Sense C2E1 for Upper arm and Sense C2E1 and Sense E2 for Lower arm .

Switching characteristics of V_{CE} also is defined between Sense C1 and Sense C2E1 for Upper arm and Sense C2E1 and Sense E2 for Lower arm .

Please use these terminals whenever measure spike voltage and on-state voltage .

WARNING

1. This Catalog contains the product specifications, characteristics, data, materials, and structures as of June 2015. The contents are subject to change without notice for specification changes or other reasons. When using a product listed in this Catalog, be sure to obtain the latest specifications.
2. All applications described in this Catalog exemplify the use of Fuji's products for your reference only. No right or license, either express or implied, under any patent, copyright, trade secret or other intellectual property right owned by Fuji Electric Co., Ltd. is (or shall be deemed) granted. Fuji Electric Co., Ltd. makes no representation or warranty, whether express or implied, relating to the infringement or alleged infringement of other's intellectual property rights which may arise from the use of the applications described herein.
3. Although Fuji Electric Co., Ltd. is enhancing product quality and reliability, a small percentage of semiconductor products may become faulty. When using Fuji Electric semiconductor products in your equipment, you are requested to take adequate safety measures to prevent the equipment from causing a physical injury, fire, or other problem if any of the products become faulty. It is recommended to make your design fail-safe, flame retardant, and free of malfunction.
4. The products introduced in this Catalog are intended for use in the following electronic and electrical equipment which has normal reliability requirements.

• Computers	• OA equipment	• Communications equipment (terminal devices)	• Measurement equipment
• Machine tools	• Audiovisual equipment	• Electrical home appliances	• Personal equipment
			• Industrial robots etc.
5. If you need to use a product in this Catalog for equipment requiring higher reliability than normal, such as for the equipment listed below, it is imperative to contact Fuji Electric Co., Ltd. to obtain prior approval. When using these products for such equipment, take adequate measures such as a backup system to prevent the equipment from malfunctioning even if a Fuji's product incorporated in the equipment becomes faulty.

• Transportation equipment (mounted on cars and ships)	• Trunk communications equipment
• Traffic-signal control equipment	• Gas leakage detectors with an auto-shut-off feature
• Emergency equipment for responding to disasters and anti-burglary devices	• Safety devices
• Medical equipment	
6. Do not use products in this Catalog for the equipment requiring strict reliability such as the following and equivalents to strategic equipment (without limitation).

• Space equipment	• Aeronautic equipment	• Nuclear control equipment
• Submarine repeater equipment		
7. Copyright ©1996-2015 by Fuji Electric Co., Ltd. All rights reserved.
No part of this Catalog may be reproduced in any form or by any means without the express permission of Fuji Electric Co., Ltd.
8. If you have any question about any portion in this Catalog, ask Fuji Electric Co., Ltd. or its sales agents before using the product. Neither Fuji Electric Co., Ltd. nor its agents shall be liable for any injury caused by any use of the products not in accordance with instructions set forth herein.

Technical Information

IGBT Modules

- Please refer to URLs below for further information about products, application manuals and design support.
- 关于本规格书中没有记载的产品信息·应用手册·技术信息等·请参考以下链接。
- 本データシートに記載されていない製品情報，アプリケーションマニュアル，デザインサポートは以下の URL をご参照下さい。

FUJI ELECTRIC Power Semiconductor WEB site

日本	www.fujielectric.co.jp/products/semiconductor/
Global	www.fujielectric.com/products/semiconductor/
中国	www.fujielectric.com.cn/products/semiconductor/
Europe	www.fujielectric-europe.com/en/power_semiconductor/
North America	www.americas.fujielectric.com/components/semiconductors/

Information

日本

1 半導体総合カタログ	www.fujielectric.co.jp/products/semiconductor/catalog/
2 製品情報	www.fujielectric.co.jp/products/semiconductor/model/
3 アプリケーションマニュアル	www.fujielectric.co.jp/products/semiconductor/model/igbt/application/
4 デザインサポート	www.fujielectric.co.jp/products/semiconductor/model/igbt/technical/
5 マウンティングインストラクション	www.fujielectric.co.jp/products/semiconductor/model/igbt/mounting/
6 IGBT 損失シミュレーションソフト	www.fujielectric.co.jp/products/semiconductor/model/igbt/simulation/
7 富士電機技報	www.fujielectric.co.jp/products/semiconductor/journal/
8 製品のお問い合わせ	www.fujielectric.co.jp/products/semiconductor/contact/
9 改廃のお知らせ	www.fujielectric.co.jp/products/semiconductor/discontinued/

Global

1 Semiconductors General Catalog	www.fujielectric.com/products/semiconductor/catalog/
2 Product Information	www.fujielectric.com/products/semiconductor/model/
3 Application Manuals	www.fujielectric.com/products/semiconductor/model/igbt/application/
4 Design Support	www.fujielectric.com/products/semiconductor/model/igbt/technical/
5 Mounting Instructions	www.fujielectric.com/products/semiconductor/model/igbt/mounting/
6 IGBT Loss Simulation Software	www.fujielectric.com/products/semiconductor/model/igbt/simulation/
7 Fuji Electric Journal	www.fujielectric.com/products/semiconductor/journal/
8 Contact	www.fujielectric.com/products/semiconductor/contact/
9 Revised and discontinued product information	www.fujielectric.com/products/semiconductor/discontinued/

中国

1 半导体综合目录	www.fujielectric.com.cn/products/semiconductor/catalog/
2 产品信息	www.fujielectric.com.cn/products/semiconductor/model/
3 应用手册	www.fujielectric.com.cn/products/semiconductor/model/igbt/application/
4 技术信息	www.fujielectric.com.cn/products/semiconductor/model/igbt/technical/
5 安装说明书	www.fujielectric.com.cn/products/semiconductor/model/igbt/mounting/
6 IGBT 损耗模拟软件	www.fujielectric.com.cn/products/semiconductor/model/igbt/simulation/
7 富士电机技报	www.fujielectric.com.cn/products/semiconductor/journal/
8 产品咨询	www.fujielectric.com.cn/products/semiconductor/contact/
9 产品更改和停产信息	www.fujielectric.com.cn/products/semiconductor/discontinued/