

20W isolated DC-DC converter in DIP package  
Ultra-wide input, regulated single output



## FEATURES

- Ultra-wide 4:1 input voltage range
- High efficiency up to 89%
- No-load power consumption as low as 0.12W
- Operating ambient temperature range: -40°C to +85°C
- Reinforced insulation, I/O isolation test voltage 5k VAC, rated for 250VAC working voltage
- Transformer creepage 8mm, Transformer clearance 8mm
- Low leakage current < 5 μA
- Meets CISPR32/EN55032 CLASS A, without extra components
- Input under-voltage protection, output short-circuit, over-current, over-voltage protection
- Industry standard pin-out

URH\_LP-20WR3 series of isolated 20W DC-DC products with a 4:1 input voltage range. They feature efficiencies of up to 89%, 5000VAC input to output isolation, output over-voltage, output short-circuit protection. They meet CLASS A of CISPR32/EN55032 EMI standards without extra components. They are widely used in high isolation required area such as medical application.

## Selection Guide

Certification	Part No.	Input Voltage (VDC)		Output		Full Load Efficiency (%) Min./Typ.	Capacitive Load (μF)Max.
		Nominal (Range)	Max. <sup>①</sup>	Voltage (VDC)	Current (mA) Max./Min.		
EN/BS EN	URH2403LP-20WR3	24 (9-36)	40	3.3	5000/0	83/85	10000
	URH2405LP-20WR3			5	4000/0	83/85	10000
	URH2412LP-20WR3			12	1666/0	84/86	4700
	URH2415LP-20WR3			15	1333/0	85/87	1600
	URH2424LP-20WR3			24	833/0	87/89	470
	URH4803LP-20WR3	48 (18-75)	80	3.3	5000/0	83/85	10000
	URH4805LP-20WR3			5	4000/0	85/87	10000
	URH4812LP-20WR3			12	1666/0	84/86	4700
	URH4815LP-20WR3			15	1333/0	84/86	1600
	URH4824LP-20WR3			24	833/0	87/89	470

Note: ① Exceeding the maximum input voltage may cause permanent damage.

## Input Specifications

Item	Operating Conditions		Min.	Typ.	Max.	Unit
Input Current (full load / no-load)	24VDC input	3.3V, 5V output	--	969/40	992/50	mA
		Others	--	958/8	992/15	
	48VDC input	3.3V, 5V output	--	479/20	491/30	
		Others	--	473/5	491/10	
Reflected Ripple Current	24VDC input		--	30	--	
	48VDC input		--	30	--	
Surge Voltage (1sec. max.)	24VDC input		-0.7	--	50	VDC
	48VDC input		-0.7	--	100	
Start-up Voltage	24VDC input		--	--	9	VDC
	48VDC input		--	--	18	
Input Under-voltage Protection	24VDC input		5.5	6.5	--	VDC
	48VDC input		12	15.5	--	
Input Filter			PI filter			

Hot Plug		Unavailable			
Ctrl <sup>①</sup>	Module on	Ctrl pin open or pulled high (3.5-12VDC)			
	Module off	Ctrl pin pulled low to GND (0-1.2VDC)			
	Input current when off	--	4	8	mA

Note: ①The Ctrl pin voltage is referenced to input GND.

### Output Specifications

Item	Operating Conditions		Min.	Typ.	Max.	Unit
Voltage Accuracy			--	±1	±2	%
Linear Regulation	Input voltage variation from low to high at full load		--	±0.2	±0.5	
Load Regulation <sup>①</sup>	5%-100% load		--	±0.5	±1	
Transient Recovery Time	25% load step change, nominal input voltage		--	300	500	μs
Transient Response Deviation		3.3V <sup>②</sup> , 5V output	--	±5	±8	%
	Others	--	±3	±5		
Temperature Coefficient	Full load		--	--	±0.03	%/°C
Ripple & Noise <sup>②</sup>	20MHz bandwidth	3.3V, 5V output	--	100	200	mVp-p
		URH2415LP-20WR3 URH2424LP-20WR3 URH4824LP-20WR3	--	80	150	
		URH2412LP-20WR3 URH4812LP-20WR3 URH4815LP-20WR3	--	50	100	
Over-current Protection	Input voltage range		110	180	260	%Io
Over-voltage Protection			110	--	160	%Vo
Short-circuit Protection			Continuous, self-recovery			
Trim			--	±10	--	%Vo

Notes:  
 ①Load regulation for 0%-100% load is ±5% max.;  
 ②Ripple & Noise of 3.3VDC/5VDC output converter for 0%-5% load is ±10% max; Ripple & Noise of other output converter for 0%-5% load is 5%Vo max. The "parallel cable" method is used for Ripple and Noise test, please refer to DC-DC Converter Application Notes for specific information;  
 ③It is required connecting an external 270uF electrolytic capacitor for 3.3V output voltage model.

### General Specifications

Item	Operating Conditions	Min.	Typ.	Max.	Unit
Isolation	Input-output Electric Strength test for 1 minute with a leakage current of 1mA max.	5000	--	--	VAC
Insulation Resistance	Input-output resistance at 500VDC	10000	--	--	MΩ
Isolation Capacitance	Input-output capacitance at 100kHz/0.1V	--	40	--	pF
Patient Leakage Current	240VAC/60Hz	--	3.6	5	uA
Reinforced Insulation	Transformer creepage	8.0	--	--	mm
	Transformer clearance	8.0	--	--	
Operating Temperature	See Fig. 1	-40	--	85	°C
Storage Humidity	Non-condensing	5	--	95	%RH
Storage Temperature		-55	--	125	°C
Pin Soldering Resistance Temperature	Wave-soldering (Soldering time: 10s)	--	--	260	
	Soldering spot is 1.5mm away from case for 10 seconds	--	--	300	
Vibration		10-150Hz, 5G, 0.75mm. along X, Y and Z			
Switching Frequency <sup>①</sup>	PWM mode(nominal input voltage, full load)	--	280	--	kHz
MTBF	MIL-HDBK-217F@25°C	1000	--	--	k hours

Note: ①Switching frequency is measured at full load. The module reduces the switching frequency for light load (below 50%) efficiency improvement.

Mechanical Specifications

Case Material	Black plastic; flame-retardant and heat-resistant (UL94-V0)
Dimensions	51.50 x 26.50 x 12.00 mm
Weight	27.0g(Typ.)
Cooling Method	Free air convection

Electromagnetic Compatibility (EMC)

Emissions	CE	URH2412LP-20WR3	CISPR32/EN55032	CLASS A (without extra components) CLASS B (see Fig.3 for recommended circuit)
		Others	CISPR32/EN55032	CLASS A (without extra components) CLASS B (see Fig.4-② for recommended circuit)
	RE	URH2412LP-20WR3	CISPR32/EN55032	CLASS B (without extra components)
		Others	CISPR32/EN55032	CLASS A (without extra components) CLASS B (see Fig.4-② for recommended circuit)
Immunity	ESD	IEC/EN61000-4-2	air ±15kV, contact ±8kV	perf. Criteria B
	RS	IEC/EN61000-4-3	10V/m	perf. Criteria A
	EFT	IEC/EN61000-4-4	100kHz ±2kV (see Fig.4-① for recommended circuit)	perf. Criteria B
	Surge	IEC/EN61000-4-5	line to line ±2kV (see Fig.4-① for recommended circuit)	perf. Criteria B
	CS	IEC/EN61000-4-6	10 Vr.m.s	perf. Criteria A
	PFM	IEC/EN61000-4-8	30 A/m, continuous	perf. Criteria A

Typical Characteristic Curves

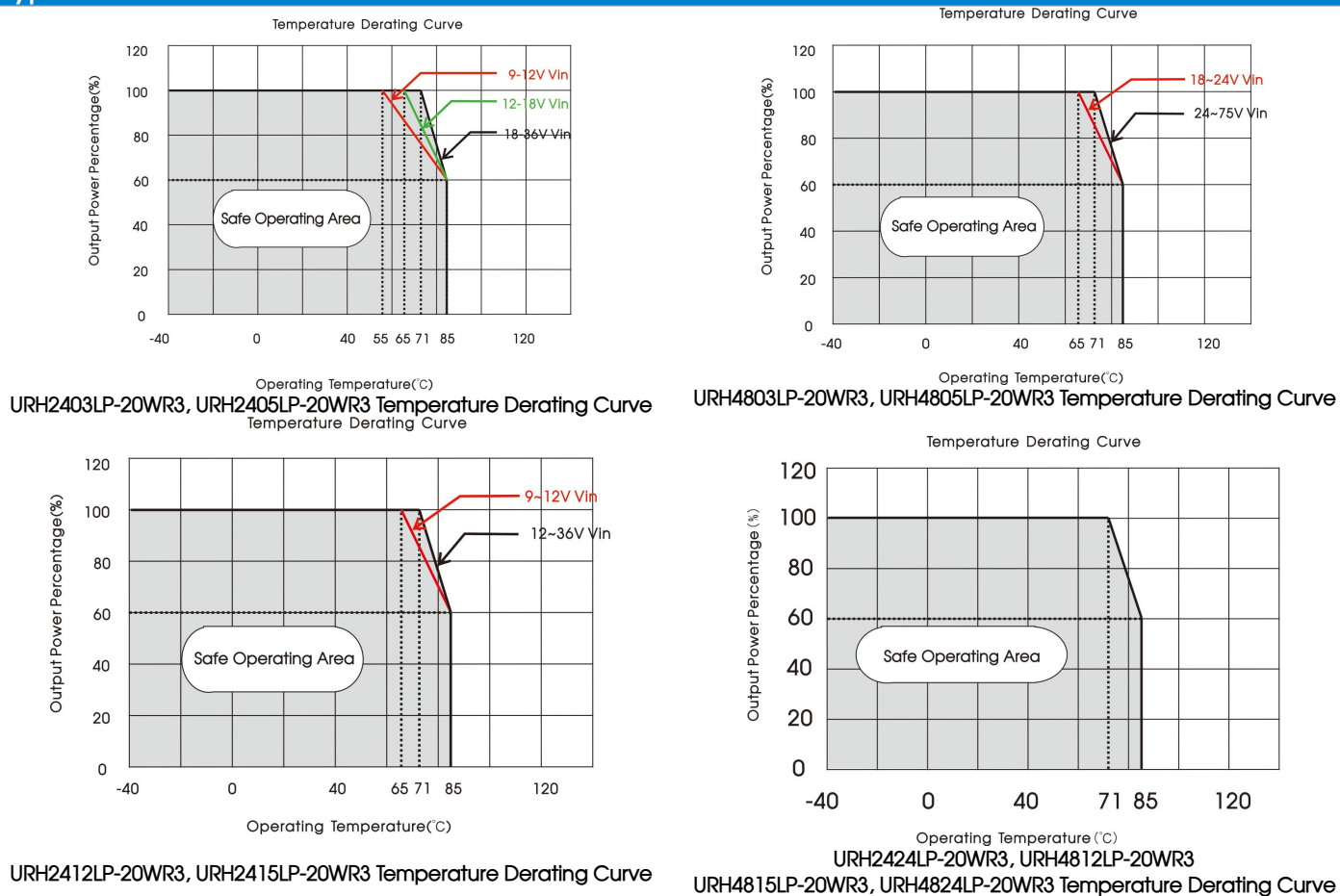
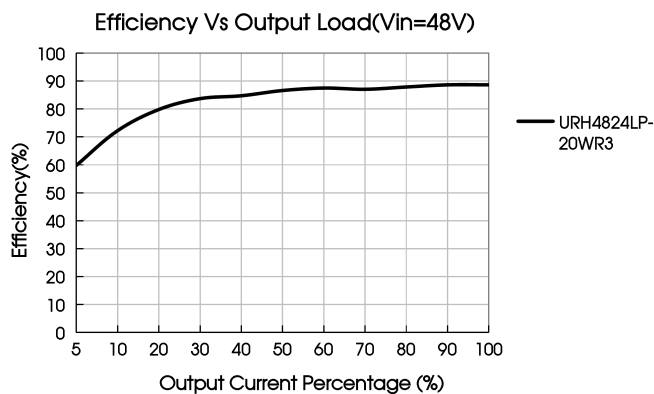
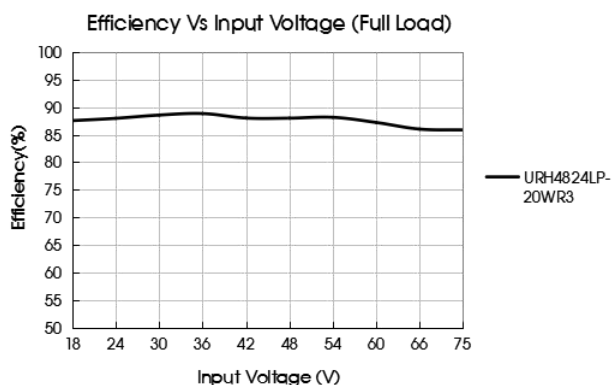
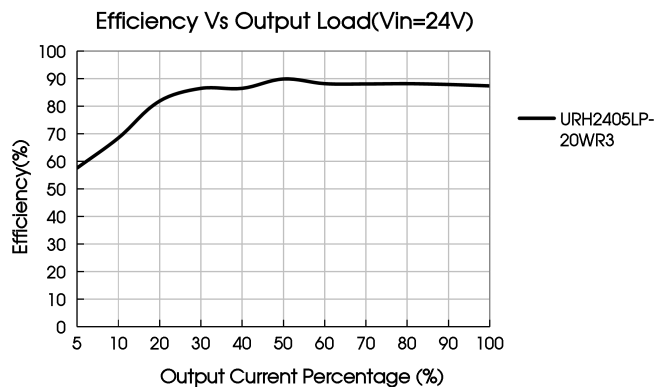
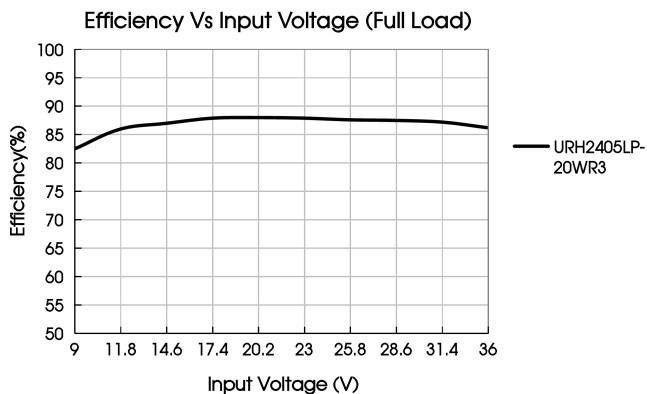

Fig. 1



## Design Reference

### 1. Typical application

All the DC/DC converters of this series are tested before delivery using the recommended circuit shown in Fig. 2. Input and/or output ripple can be further reduced by appropriately increasing the input & output capacitor values  $C_{in}$  and  $C_{out}$  and/or by selecting capacitors with a low ESR (equivalent series resistance). Also make sure that the capacitance is not exceeding the specified max. capacitive load value of the product.

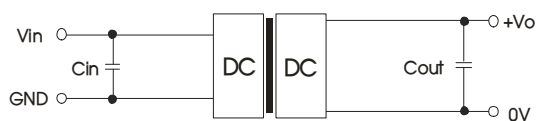

Fig. 2

Vin (VDC)	Vout (VDC)	Cin	Cout
24	3.3	100μF/50VDC	270μF/16VDC
	5		10μF/16VDC
	12/15		10μF/25VDC
	24		10μF/50VDC
48	3.3	10~47μF/100VDC	270μF/16VDC
	5		10μF/16VDC
	12/15		10μF/25VDC
	24		10μF/50VDC

### 2. EMC compliance circuit

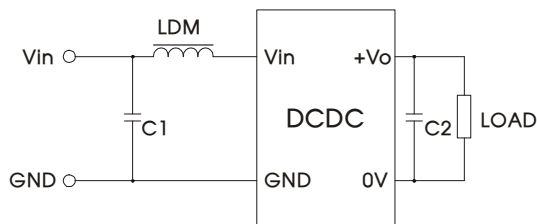

Fig. 3

#### Parameter description

Model	URH2412LP-20WR3
C1	10μF/50V
C2	Refer to the Cout in Fig.2
LDM	4.7μH

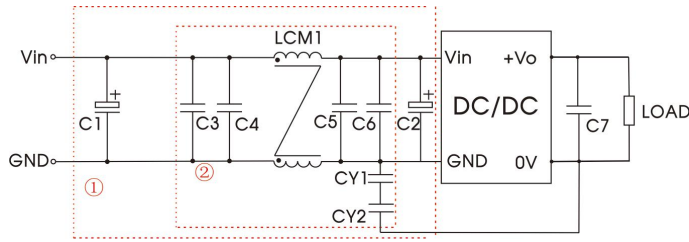

Fig. 4

Parameter description

Model	Vin: 24VDC	Vin: 48VDC
C1/C2	680µF/50V	330µF/100V
C3/C4 C5/C6	10µF/50V	10µF/100V
C7	Refer to the Cout in Fig.2	
LCM1	2.2mH	
CY1/ CY2	Y1: 47pF/400VAC (12V/15V/24V output no need)	

Notes: For EMC tests we use Part ① in Fig. 4 for immunity and part ② for emissions test. Selecting based on needs.

3. Trim Function for Output Voltage Adjustment (open if unused)

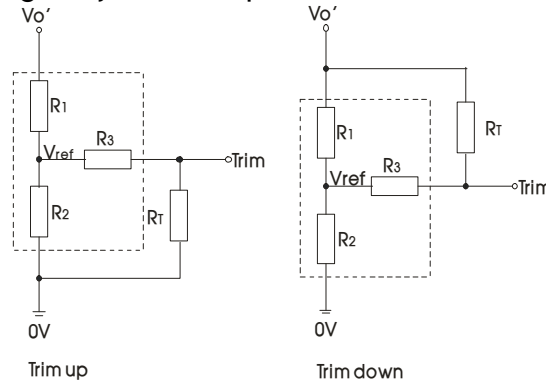

TRIM resistor connection (dashed line shows internal resistor network)

Calculating Trim resistor values:

$$\begin{aligned} \text{up: } R_T &= \frac{\alpha R_2}{R_2 - \alpha} \cdot R_3 & \alpha &= \frac{V_{ref}}{V_{o'} - V_{ref}} \cdot R_1 \\ \text{down: } R_T &= \frac{\alpha R_1}{R_1 - \alpha} \cdot R_3 & \alpha &= \frac{V_{o'} - V_{ref}}{V_{ref}} \cdot R_2 \end{aligned}$$

R<sub>T</sub> = Trim Resistor value;  
α = self-defined parameter.

Vout(V)	R1(kΩ)	R2(kΩ)	R3(kΩ)	Vref(V)
3.3	4.801	2.87	10	1.24
5	2.883	2.87	8.2	2.5
12	10.909	2.87	15	2.5
15	14.354	2.87	15	2.5
24	24.771	2.87	17.4	2.5

4. The products do not support parallel connection of their output

5. For additional information please refer to DC-DC converter application notes on [www.mornsun-power.com](http://www.mornsun-power.com)

Dimensions and Recommended Layout

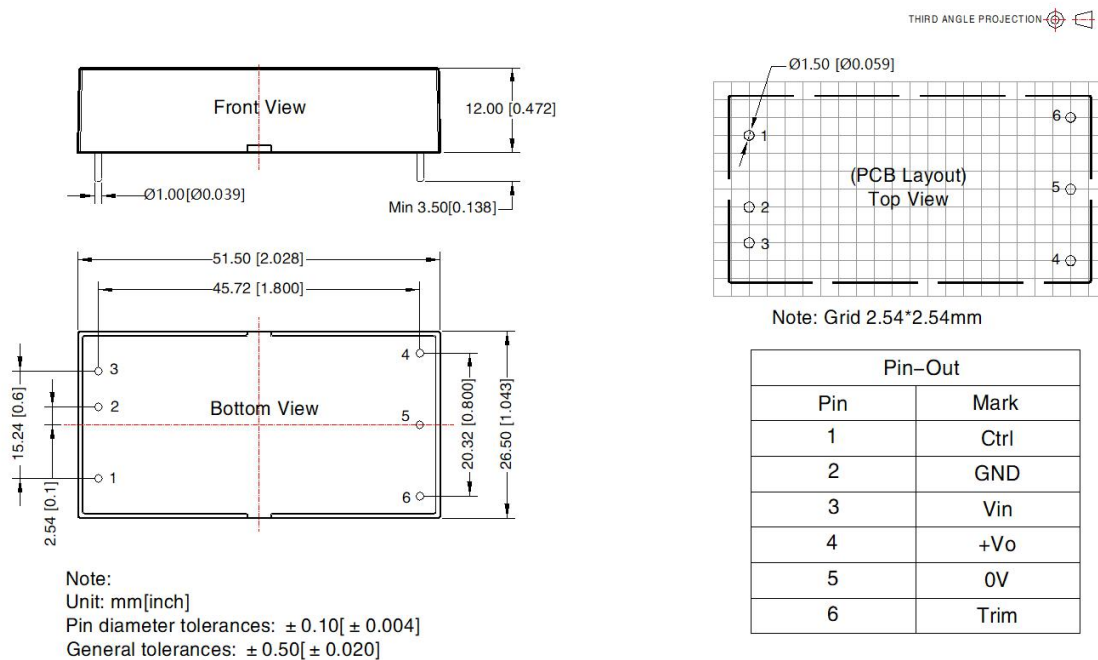

Note:

1. For additional information on Product Packaging please refer to [www.mornsun-power.com](http://www.mornsun-power.com). Packaging bag number: 58210039;
2. The maximum capacitive load offered were tested at input voltage range and full load;
3. Unless otherwise specified, parameters in this datasheet were measured under the conditions of  $T_a=25^\circ\text{C}$ , humidity<75%RH with nominal input voltage and rated output load;
4. All index testing methods in this datasheet are based on company corporate standards;
5. We can provide product customization service, please contact our technicians directly for specific information;
6. Products are related to laws and regulations: see "Features" and "EMC";
7. Our products shall be classified according to ISO14001 and related environmental laws and regulations, and shall be handled by qualified units.

Mornsun Guangzhou Science & Technology Co., Ltd.

Address: No. 5, Kehui St. 1, Kehui Development Center, Science Ave., Guangzhou Science City, Huangpu District, Guangzhou, P. R. China  
Tel: 86-20-38601850 Fax: 86-20-38601272 E-mail: [info@mornsun.cn](mailto:info@mornsun.cn) [www.mornsun-power.com](http://www.mornsun-power.com)